

DREAM SERVICE TEAM  
POOL SAUNA SPA DESIGN

2022

PRICE LIST

[WWW.DSTPOOL.COM](http://WWW.DSTPOOL.COM)



# ADDRESSES:

## ISTANBUL

Mehmet Akif Mah. Öztekin Cad. No:24/A  
ÜMRANIYE +90(216)999 06 57



DREAM SERVICE TEAM



## IZMIR

1202/1 sok. No: 81/A EGE TİC. MRKZ. - 35110  
YENİŞEHİR +90(232)457 64 23



# INDEX

- 4** Polyester Sand Filters
- 15** Filter Sand
- 17** Pumps
- 20** Pool Cleaning Equipment
- 28** Pool Chemicals
- 30** Ladders
- 34** Pool Waterfalls
- 36** Corner Pieces & Grates
- 38** Nozzles
- 40** Pool Lighting
- 44** PVC Fast Adhesive



**4**



**17**



**20**



**28**



# POLYESTER SAND FILTERS



# DST DREAM POLYESTER SAND FILTERS



- DST DREAM POLYESTER SAND FILTERS are made of a laminated polyester and reinforced with glass fibers.
- Filters are manufactured in 12 different diameters and they have 30 different color options.
- A special production technique is used to prevent density differences on the filter surface.
- Maximum Working Pressure 1,96 bar and Test Pressure is 3,92 bar.
- Maximum Working Temperature 40 °C. DST DREAM SAND FILTER bodies have a five-year warranty

| CODE       | DESCRIPTION       | FLOW (M3/H/M2) | CONNECTION (MM) | WEIGHT | SAND (KG) | PRICE (EURO) |
|------------|-------------------|----------------|-----------------|--------|-----------|--------------|
| DST FLT001 | 500mm Sand Filter | 9              | D 50 (1 1/2")   | 18     | 75        | 290,00 EUR   |
| DST FLT002 | 650mm Sand Filter | 16             | D 50 (1 1/2")   | 22     | 150       | 397,00 EUR   |
| DST FLT003 | 750mm Sand Filter | 22             | D 63 (2")       | 32     | 300       | 487,00 EUR   |
| DST FLT004 | 800mm Sand Filter | 25             | D 63 (2")       | 34     | 375       | 549,00 EUR   |
| DST FLT005 | 950mm Sand Filter | 32             | D 63 (2")       | 40     | 450       | 587,00 EUR   |



| CODE       | DESCRIPTION       | N (MM) | M (MM) | H (MM) | D (MM) |
|------------|-------------------|--------|--------|--------|--------|
| DST FLT001 | 500mm Sand Filter | 300    | 420    | 800    | 500    |
| DST FLT002 | 650mm Sand Filter | 320    | 440    | 900    | 650    |
| DST FLT003 | 750mm Sand Filter | 360    | 560    | 1030   | 750    |
| DST FLT004 | 800mm Sand Filter | 380    | 580    | 1080   | 800    |
| DST FLT005 | 950mm Sand Filter | 380    | 580    | 1080   | 950    |

# DST DREAM COMMERCIAL POLYESTER SAND FILTERS



- DST DREAM POLYESTER COMMERCIAL SAND FILTERS are made of a laminated polyester and reinforced with glass fibers. Filters have 30 different color options.
- A special production technique is used to prevent density differences on the filter surface.
- Maximum Working Pressure 1,96 bar and Test Pressure is 3,92 bar.
- Maximum Working Temperature 40 °C. DST DREAM SAND FILTER bodies have a five-year warranty

| CODE        | DESCRIPTION        | FLOW (M3/H/M2) | CONNECTION (MM)      | WEIGHT | SAND (KG) | PRICE (EURO) |
|-------------|--------------------|----------------|----------------------|--------|-----------|--------------|
| DST FLT006  | 1050mm Sand Filter | 43             | D 75 (2 1/2")        | 60     | 650       | 1.000,00 EUR |
| DST FLT007  | 1250mm Sand Filter | 56             | D 90 (3")            | 85     | 1250      | 1.250,00 EUR |
| DST FLT008  | 1400mm Sand Filter | 77             | D 110 (4" )          | 190    | 2000      | 2.125,00 EUR |
| DST FLT009  | 1600mm Sand Filter | 100            | 110-125 (4"- 4 1/2") | 230    | 3000      | 2.375,00 EUR |
| DST FLT0010 | 1800mm Sand Filter | 125            | D 140 (5")           | 250    | 3750      | 3.000,00 EUR |
| DST FLT0011 | 2000mm Sand Filter | 150            | D 160 (6")           | 280    | 4350      | 3.750,00 EUR |
| DST FLT0012 | 2200mm Sand Filter | 200            | D 160 (6")           | 320    | 6000      | 7.000,00 EUR |

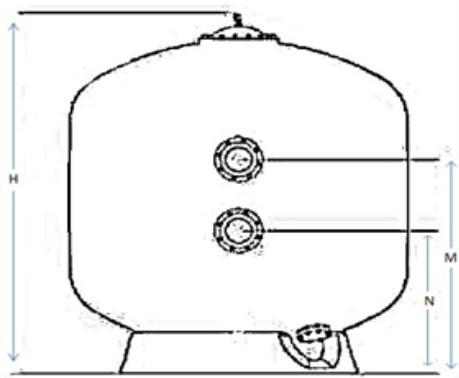

| CODE        | DESCRIPTION        | N (MM) | M(MM) | H(MM) | D(MM) |
|-------------|--------------------|--------|-------|-------|-------|
| DST FLT006  | 1050mm Sand Filter | 430    | 930   | 1500  | 1050  |
| DST FLT007  | 1250mm Sand Filter | 560    | 900   | 1550  | 1250  |
| DST FLT008  | 1400mm Sand Filter | 650    | 980   | 1630  | 1400  |
| DST FLT009  | 1600mm Sand Filter | 900    | 1320  | 1880  | 1600  |
| DST FLT0010 | 1800mm Sand Filter | 460    | 1250  | 1900  | 1800  |
| DST FLT0011 | 2000mm Sand Filter | 820    | 1340  | 2080  | 2000  |
| DST FLT0012 | 2200mm Sand Filter | 820    | 1340  | 2360  | 2200  |

# DST PRO DREAM POLYESTER SAND FILTERS

- DST PRO DREAM polyester sand filters are manufactured according to DIN standards.
- DST PRO DREAM polyester sand filters are made from a laminated polyester and reinforced with glass fibers.
- Filters manufactured with collector plate + nozzles. Sand level is 1,2m. Filter top cover 250mm and all filters include pressure gauge and purge.
- Filters are manufactured in 12 different diameters and they have 30 different color options. Maximum working pressure 1,96 bar and test pressure is 3.92 bar.
- Maximum working temperature 40 °C. DST PRO DREAM sand filters have a five-year warranty.
- DST PRO DREAM polyester sand filters are compatible with multiport valves

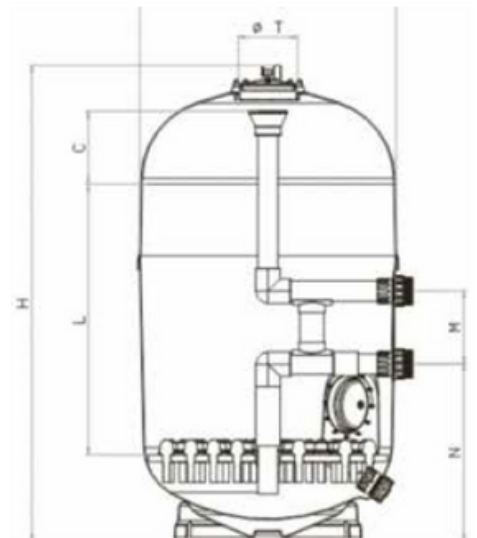

| CODE       | VELOCITY (M3/H/M2) | FLOW (M3/H/M2) | F.A (M2) | CONNECTION | WEIGHT (KG) | SAND (KG) | N (MM) | M (MM) | H (MM) | L (MM) | C (MM) | PRICE (EURO) |
|------------|--------------------|----------------|----------|------------|-------------|-----------|--------|--------|--------|--------|--------|--------------|
| DSTDFM 650 | 50                 | 16,5           | 0,33     | 1"1/2      | 70          | 570       | 730    | 125    | 2145   | 1200   | 1200   | 1.430,00 EUR |
| DSTDFM 820 | 50                 | 25             | 0,5      | 2"         | 85          | 825       | 670    | 230    | 2145   | 1950   | 1200   | 1.980,00 EUR |
| DSTDFM 950 | 50                 | 35             | 0,7      | 2,5"       | 120         | 1275      | 665    | 270    | 2170   | 1960   | 1200   | 2.530,00 EUR |

# DST PRO DREAM POLYESTER SAND FILTERS

- DST PRO DREAM polyester sand filters are manufactured according to DIN standards.
- DST PRO DREAM polyester sand filters are made from a laminated polyester and reinforced with glass fibers.
- Filters manufactured with collector plate + nozzles. Sand level is 1,2m. Filter top cover 400mm, sight cover for 1050mm and 1250mm is 250mm, for 1400-1600-1800-2000mm and all filters include pressure gauge and purge.
- Filters are manufactured in 12 different diameters and they have 30 different color options. Maximum working pressure 1,96 bar and test pressure is 3.92 bar.
- Maximum working temperature 40 °C. Filters include sight Glass. DST PRO DREAM sand filters have a five-year warranty.
- DST PRO DREAM polyester sand filters are compatible with multiport valves

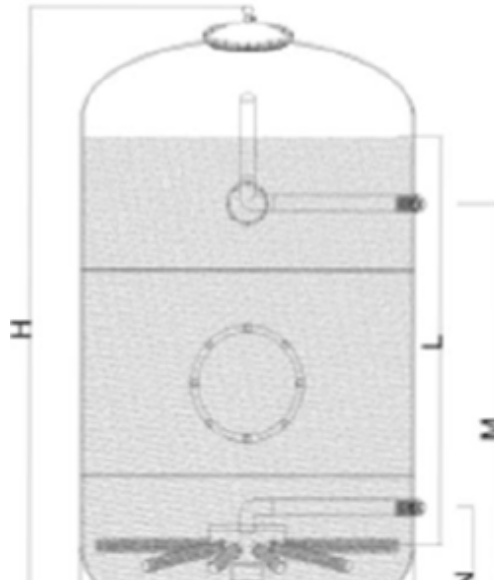

| CODE         | VELOCITY (M3/H/M2) | FLOW (M3/H/M2) | F.A (M2) | CONNECTION    | WEIGHT (KG) | SAND (KG) | N (MM) | M (MM) | H (MM) | L (MM) | C (MM) | PRICE (EURO)  |
|--------------|--------------------|----------------|----------|---------------|-------------|-----------|--------|--------|--------|--------|--------|---------------|
| DSTDFMC 1050 | 30                 | 25,8           | 0.86     | D 75(2 1/2")  | 135         | 1560      | 665    | 270    | 2145   | 1200   | 300    | 3.080.00 EUR  |
|              | 40                 | 34,4           | 0.86     | D 90(3")      | 135         | 1560      | 665    | 270    | 2145   | 1200   | 300    | 3.487.00 EUR  |
| DSTDFMC 1250 | 30                 | 33,9           | 1.13     | D 90(3")      | 210         | 2075      | 665    | 270    | 2170   | 1200   | 300    | 3.630.00 EUR  |
|              | 40                 | 45,2           | 1.13     | D 110(4")     | 210         | 2075      | 665    | 270    | 2170   | 1200   | 300    | 3.960.00 EUR  |
| DSTDFMC 1400 | 30                 | 46,5           | 1.55     | D 110(4")     | 260         | 2300      | 520    | 1050   | 2200   | 1200   | 300    | 5.280.00 EUR  |
|              | 40                 | 62             | 1.55     | D 125(4 1/2") | 260         | 2300      | 520    | 1050   | 2200   | 1200   | 300    | 5.610.00 EUR  |
| DSTDFMC 1600 | 30                 | 60,3           | 2.01     | D 125(4 1/2") | 320         | 3000      | 540    | 1160   | 2480   | 1200   | 300    | 6.050.00 EUR  |
|              | 40                 | 80,04          | 2.01     | D 140(5")     | 320         | 3000      | 540    | 1160   | 2480   | 1200   | 300    | 6.600.00 EUR  |
| DSTDFMC 1800 | 30                 | 76,2           | 2.54     | D 140(5")     | 380         | 3800      | 550    | 1200   | 2550   | 1200   | 300    | 7.700.00 EUR  |
|              | 40                 | 101,6          | 2.54     | D 160(6")     | 380         | 3800      | 550    | 1200   | 2550   | 1200   | 300    | 8.580.00 EUR  |
| DSTDFMC 2000 | 30                 | 94,2           | 3.14     | D 140(5")     | 450         | 4675      | 550    | 1330   | 2550   | 1200   | 300    | 9.680.00 EUR  |
|              | 40                 | 125,6          | 3.14     | D 160(6")     | 450         | 4675      | 550    | 1330   | 2550   | 1200   | 300    | 10.450.00 EUR |



# DST PRO DREAM POLYESTER SAND FILTERS

- DST PRO DREAM polyester sand filters are manufactured according to DIN standards.
- DST PRO DREAM polyester sand filters are made from a laminated polyester and reinforced with glass fibers. Filters manufactured with collector and lateral.
- Sand level is 1,2m. Filter top cover 250mm and all filters include pressure gauge and purge.
- Filters are manufactured in 12 different diameters and they have 30 different color options.
- Maximum working pressure 1,96 bar and test pressure is 3.92 bar. Maximum working temperature 40 °C. DST PRO DREAM sand filters have a five-year warranty.
- DST PRO DREAM polyester sand filters are compatible with multiport valves

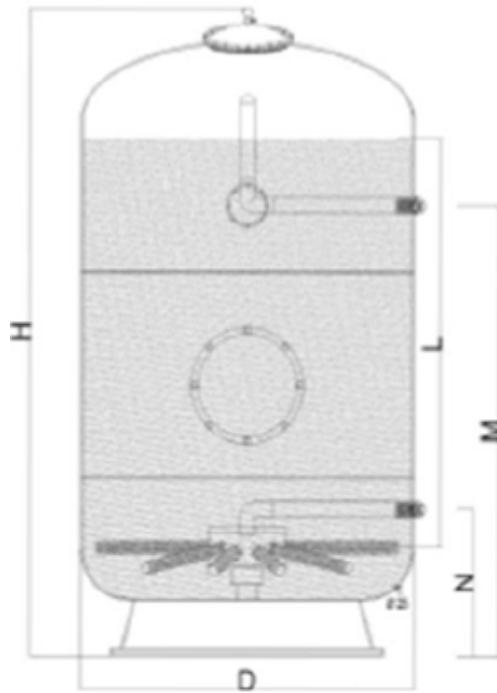

| CODE        | VELOCITY (M3/H/M2) | FLOW (M3//H) | F.A(M2) | CONNECTION | WEIGHT (KG) | SAND (KG) | N (MM) | M (MM) | H (MM) | L (MM) | PRICE (EURO) |
|-------------|--------------------|--------------|---------|------------|-------------|-----------|--------|--------|--------|--------|--------------|
| DSTDFYK 650 | 50                 | 16,5         | 0,33    | 1"1/2      | 70          | 570       | 730    | 125    | 1900   | 1200   | 1.254.00 EUR |
| DSTDFYK 820 | 50                 | 25           | 0,5     | 2"         | 85          | 825       | 670    | 230    | 1950   | 1200   | 1.826.00 EUR |
| DSTDFYK 950 | 50                 | 35           | 0,7     | 2,5"       | 120         | 1275      | 665    | 270    | 1960   | 1200   | 2.145,00 EUR |

# DST PRO DREAM POLYESTER SAND FILTERS

- DST PRO DREAM polyester sand filters are manufactured according to DIN standards. DST PRO DREAM polyester sand filters are made from a laminated polyester and reinforced with glass fibers.
- Filters manufactured with collector and lateral. Sand level is 1,0m. Filter top cover 250mm and all filters include pressure gauge and purge.
- Filters are manufactured in 12 different diameters and they have 30 different color options. Maximum working pressure 1,96 bar and test pressure is 3.92 bar.
- Maximum working temperature 40 °C. DST PRO DREAM sand filters have a five-year warranty.
- DST PRO DREAM polyester sand filters are compatible with multiport valves

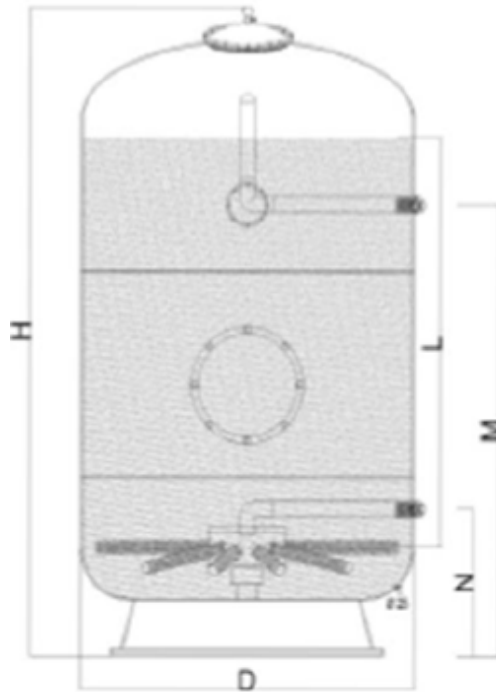

| CODE         | VELOCITY (M3/H/M2) | FLOW (M3//H) | F.A (M2) | CONNECTION | WEIGHT (KG) | SAND (KG) | N (MM) | M (MM) | H (MM) | L (MM) | PRICE (EURO) |
|--------------|--------------------|--------------|----------|------------|-------------|-----------|--------|--------|--------|--------|--------------|
| DSTDFYKK 650 | 50                 | 16,5         | 0,33     | 1 1/2"     | 70          | 570       | 730    | 125    | 1900   | 1200   | 1.144,00 EUR |
| DSTDFYKK 820 | 50                 | 25           | 0,5      | 2"         | 85          | 825       | 670    | 230    | 1950   | 1200   | 1.716,00 EUR |
| DSTDFYKK 950 | 50                 | 35           | 0,7      | 2 1/2"     | 120         | 1275      | 665    | 270    | 1960   | 1200   | 2.035,00 EUR |

# DST PRO DREAM POLYESTER SAND FILTERS

- DST PRO DREAM polyester sand filters are manufactured according to DIN standards. DST PRO DREAM polyester sand filters are made from a laminated polyester and reinforced with glass fibers.
- Filters manufactured with collector with lateral. Sand level is 1,2m. Filter top cover 400mm, sight cover for 1050mm and 1250mm is 250mm, for 1400-1600-1800-2000mm and all filters include pressure gauge and purge.
- Filters are manufactured in 12 different diameters and they have 30 different color options. Maximum working pressure 1,96 bar and test pressure is 3.92 bar.
- Maximum working temperature 40 °C. Filters include sight Glass. DST PRO DREAM sand filters have a five-year warranty.
- DST PRO DREAM polyester sand filters are compatible with multiport valves

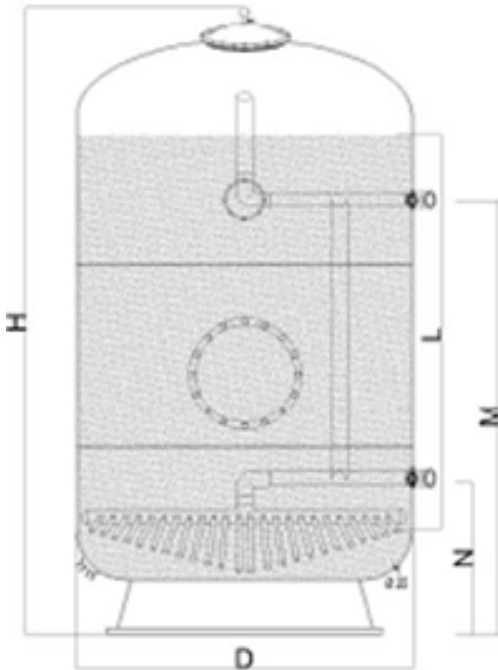

FOR DST SAND FILTERS  
MULTI WAY VALVE

| CODE     | TYPE   | PRICE     |
|----------|--------|-----------|
| DSTPRV01 | 1 1/2" | 50,00 EUR |
| DSTPRV02 | 2"     | 70,00 EUR |

| CODE          | VELOCITY (M3/H/M2) | FLOW (M3/H/M2) | F.A(M2) | CONNECTION    | WEIGHT (KG) | SAND (KG) | N(MM) | M(MM) | H(MM) | L(MM) | C(MM) | PRICE (EURO) |
|---------------|--------------------|----------------|---------|---------------|-------------|-----------|-------|-------|-------|-------|-------|--------------|
| DSTDFYKC 1050 | 30                 | 25,8           | 0.86    | D 75(2 1/2")  | 135         | 1560      | 665   | 270   | 2145  | 1200  | 300   | 3.080.00 EUR |
|               | 40                 | 34,4           | 0.86    | D 90(3")      | 135         | 1560      | 665   | 270   | 2145  | 1200  | 300   | 3.300.00 EUR |
| DSTDFYKC 1250 | 30                 | 33,9           | 1.13    | D 90(3")      | 210         | 2075      | 665   | 270   | 2170  | 1200  | 300   | 3.410.00 EUR |
|               | 40                 | 45,2           | 1.13    | D 110(4")     | 210         | 2075      | 665   | 270   | 2170  | 1200  | 300   | 3.630.00 EUR |
| DSTDFYKC 1400 | 30                 | 46,5           | 1.55    | D 110(4")     | 260         | 2300      | 520   | 1050  | 2200  | 1200  | 300   | 4.950.00 EUR |
|               | 40                 | 62             | 1.55    | D 125(4 1/2") | 260         | 2300      | 520   | 1050  | 2200  | 1200  | 300   | 5.280.00 EUR |
| DSTDFYKC 1600 | 30                 | 60,3           | 2.01    | D 125(4 1/2") | 320         | 3000      | 540   | 1160  | 2480  | 1200  | 300   | 5.610.00 EUR |
|               | 40                 | 80,04          | 2.01    | D 140(5")     | 320         | 3000      | 540   | 1160  | 2480  | 1200  | 300   | 6.160.00 EUR |
| DSTDFYKC 1800 | 30                 | 76,2           | 2.54    | D 140(5")     | 380         | 3800      | 550   | 1200  | 2550  | 1200  | 300   | 7.370.00 EUR |
|               | 40                 | 101,6          | 2.54    | D 160(6")     | 380         | 3800      | 550   | 1200  | 2550  | 1200  | 300   | 8.140.00 EUR |
| DSTDFYKC 2000 | 30                 | 94,2           | 3.14    | D 140(5")     | 450         | 4675      | 550   | 1330  | 2550  | 1200  | 300   | 9.350.00 EUR |
|               | 40                 | 125,6          | 3.14    | D 160(6")     | 450         | 4675      | 550   | 1330  | 2550  | 1200  | 300   | 9.900.00 EUR |

• WE HAVE ALTERNATIVE FILTER SAND PLEASE CONTACT US

## “Injectrone” HIGH RATE SAND FILTERS



- Made of Injection plastic (PP). The upper and lower parts are joined with a special welding technique.
- As the bed depth is higher than other filter models, the filtration quality is considerably higher.
- Sand water discharge openings are available at both front and rear, installed w/discharge valve.
- Easy to open clear screw lid (2 cm wider than bolted lid). Complete with multiway valve, fittings, and pressure gauge.
- Five years body warranty. Test pressure 3,5 kg/cm<sup>2</sup>, maximum operation pressure 2,5 kg/cm<sup>2</sup>, Maximum filtration rate 50 m<sup>3</sup>/h/m<sup>2</sup>.



| MODEL                      | 0211011 | 0211012 |
|----------------------------|---------|---------|
| D (MM)                     | 500     | 600     |
| H1(MM)                     | 960     | 1030    |
| H2(MM)                     | -       | -       |
| H3(MM)                     | 910     | 980     |
| H4(MM)                     | 290     | 320     |
| H5(MM)                     | 415     | 445     |
| W (MM)                     | 260     | 260     |
| CONNECTION (MM)            | 1 1/2"  | 1 1/2"  |
| FLOW (M3/H)<br>(50M3/H/M2) | 9,81    | 14,13   |
| SAND (KG)                  | 125     | 170     |
| WEIGHT(KG)                 | 8.000   | 11.000  |

# “Injectrone” HIGH RATE SAND FILTERS

| “INJECTRONE” HIGH RATE SAND FILTERS             | CODE        | WEIGHT (KG) | VOLUME (M3) | CONNECTION |
|---|-------------|-------------|-------------|------------|
| O 500MM - 1 1/2 multiport side valve - 10m3 / h | DST 0211011 | 17          | 0,18        | 227,00 EUR |
| O 600MM - 1 1/2 multiport side valve - 15m3 / h | DST 0211012 | 27          | 0,27        | 244,00 EUR |

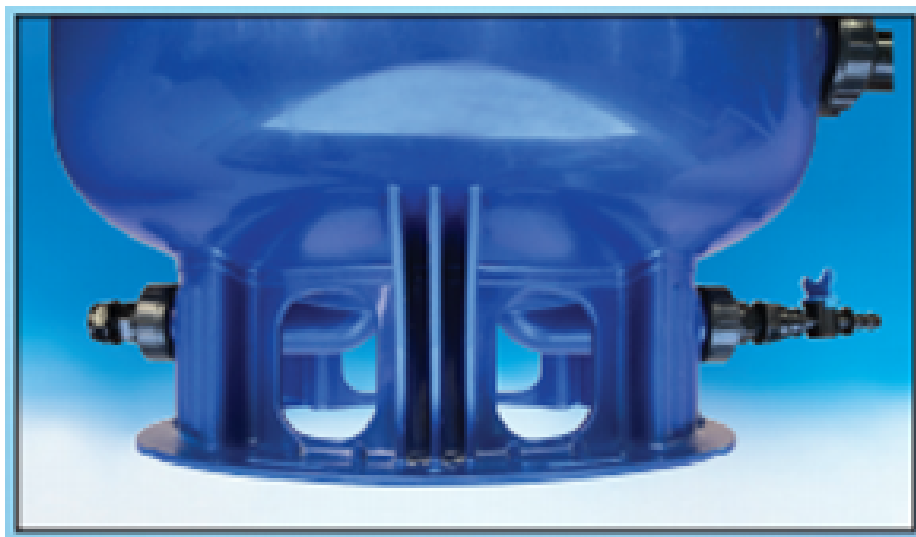
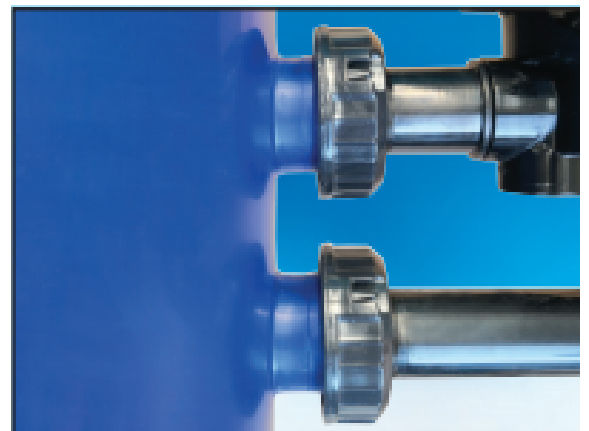

# “INJECTRONE CL” HIGH RATE SAND FILTERS

| “INJECTRONE CL” HIGH RATE SAND FILTERS          | CODE        | WEIGHT (KG) | VOLUME(M3) | CONNECTION |
|---|-------------|-------------|------------|------------|
| O 500MM - 1 1/2 multiport side valve - 10m3 / h | DST 0211011 | 17          | 0,18       | 227,00 EUR |
| O 600MM - 1 1/2 multiport side valve - 15m3 / h | DST 0211012 | 27          | 0,27       | 244,00 EUR |



- It is injected with glass reinforced plastic (PA) in two parts. Upper and lower parts are integrated with stainless steel clamp.
- Since the depth of sand bed is equal to the height of the lower part, the filter sand can be easily serviced by dismantling the clamp.
- As the bed depth is higher than other filter models, the filtration quality is considerably higher.
- and water discharge openings are available at both front and rear, installed w/discharge valve.
- Complete with multi-way valve, fittings, and pressure gauge.
- Five years body warranty. Test pressure 3,5 kg/cm<sup>2</sup>, maximum operation pressure 2,5 kg/cm<sup>2</sup>, Maximum filtration rate 50 m<sup>3</sup>/h/m<sup>2</sup>.

| MODEL                   | 0211111 | 0211112 |
|-------------------------|---------|---------|
| D (MM)                  | 500     | 600     |
| H1(MM)                  | 890     | 960     |
| H2(MM)                  | -       | -       |
| H3(MM)                  | 840     | 910     |
| H4(MM)                  | 290     | 320     |
| H5(MM)                  | 415     | 445     |
| W (MM)                  | 260     | 260     |
| CONNECTION (MM)         | 1 1/2"  | 1 1/2"  |
| FLOW (M3/H) (50M3/H/M2) | 9,81    | 14,13   |
| SAND (KG)               | 100     | 150     |
| WEIGHT (KG)             | 8.000   | 11.000  |

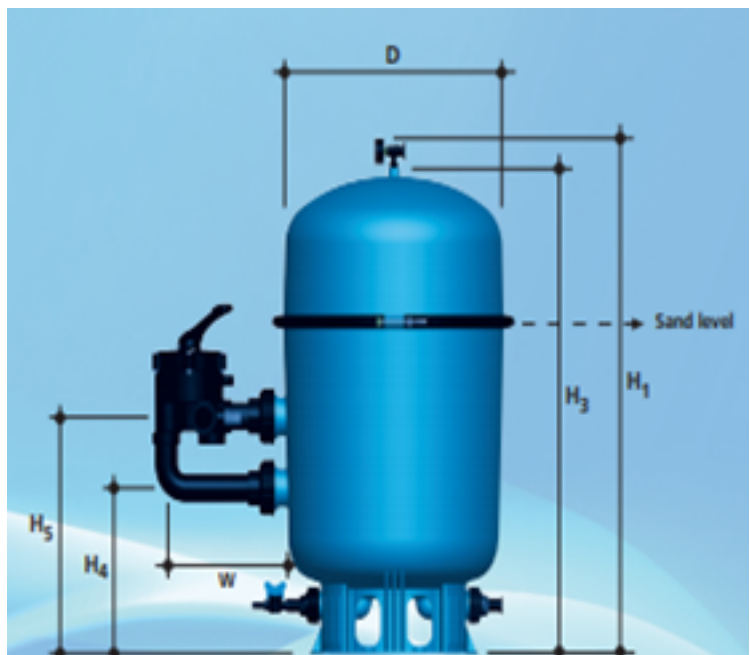

D.S.T.



DREAM SERVICE TEAM



PUMPS



## DST EPHESUS POOL PUMP

**Ephesus**  
Self-Priming Centrifugal Pump for Pools



- EPHESUS is a pool pump of horizontal centrifugal structure to provide uninterrupted circulation of water in swimming pools.
- To serve this purpose, it is installed in front of the filter in the pool installment.
- The pump is designed to move about the incoming and the outgoing water from the chlorine disinfected swimming pool.
- It is designed together with a pre-filter in order to protect the pump impeller from substances such as hair that may come from the pool.
- The plastic basket within the pre-filter can be taken out to be cleaned when necessary.

### TECHNICAL INFORMATION

**Max environment temperature:** +50°C

**Max water temperature:** +50°C

**Max working pressure:** 2 Bar

**Max inlet pressure:** Pompa basma vanası kapalı tutulduğunda, giriş basıncı izin verilen maksimum çalışma basıncından düşük olmalıdır.

| MODEL   | MAX VERTICAL SUCTION (WITH BACK FLOW VALVE) | MAX VERTICAL SUCTION (WITHOUT BACK FLOW VALVE) |
|---------|---|--|
| EPHESUS | 5 M   | 4 M  |

**Self-priming:** The EPHESUS pumps are self-priming up to 4m height.

**Noise level:** Noise level of EPHESUS pumps are below 70Db

| NO | MODEL                                | PRICE      |
|----|--------------------------------------|------------|
| 1  | DST EPHESUS 0,75 HP. MONO. POOL PUMP | 280,00 EUR |
| 2  | DST EPHESUS 1 HP. MONO. POOL PUMP    | 300,00 EUR |
| 3  | DST EPHESUS 1 HP. TRI. POOL PUMP     | 300,00 EUR |
| 4  | DST EPHESUS 1,5 HP. MONO. POOL PUMP  | 310,00 EUR |
| 5  | DST EPHESUS 1,5 HP. TRI. POOL PUMP   | 310,00 EUR |
| 6  | DST EPHESUS 2 HP. MONO. POOL PUMP    | 380,00 EUR |
| 7  | DST EPHESUS 2 HP. TRI. POOL PUMP     | 380,00 EUR |
| 8  | DST EPHESUS 3 HP. MONO. POOL PUMP    | 420,00 EUR |
| 9  | DST EPHESUS 3 HP. TRI. POOL PUMP     | 420,00 EUR |





DREAM SERVICE TEAM

# DST REGNUM POOL PUMP



- REGNUM pool pumps are designed to circulate the conditioned water of public and private swimming pools, spas.

## TECHNICAL INFORMATION

### MOTOR:

**Insulation:** Class F

**Operation:** Continuous

**Protection:** IP 55

**Current:** Triphase

**R.P.M:** 2885 or 3000

**Shaft:** Stainless Steel (AISI 316)

**Bearing:** Ball bearing

**Atmospheric Temperature:** Maximum 40°C (RGJ) 50°C (RGO)

### PUMP:

**Max water temperature:** +50°C

**Max working pressure:** 2 Bars

**Impeller Model:** Closed

**Type of Seal:** Mechanical Retainer

**Diffuser:** Synthetic Material (FRPP)

**Prefilter Lid for FLO Model:** Polycarbonate Model

**Socket Dia:** Socket 110mm

**Supply Dia:** Socket 110mm

| NO | MODEL                             | PRICE        |
|----|-----------------------------------|--------------|
| 1  | DST REGNUM 3,5 HP. TRI. POOL PUMP | 670,00 EUR   |
| 2  | DST REGNUM 4,5 HP. TRI. POOL PUMP | 710,00 EUR   |
| 3  | DST REGNUM 5,5 HP. TRI. POOL PUMP | 740,00 EUR   |
| 4  | DST REGNUM 7,5 HP. TRI. POOL PUMP | 1.000,00 EUR |
| 5  | DST REGNUM 10 HP. TRI. POOL PUMP  | 1.200,00 EUR |

| PRODUCT    | DESCRIPTION              | PRICE     |
|------------|--------------------------|-----------|
| PUMP STAND | DST PUMP STAND (PLASTIC) | 20,00 EUR |



D.S.T



DREAM SERVICE TEAM



# POOL CLEANING EQUIPMENT



# “Standart” Automatic Pool Cleaners

## DOLPHIN “E 10” AUTOMATIC POOL CLEANERS:



- Designed for residential pools up to 8 m, 24 V motor unit and 12 m cable. Lightweight, easy to carry. Cleaning cycle time 1,5 hours. Automatic program for optimal pool cleaning. With the help of active brush which moves twice times faster than robot, removes the algea and bacteria on the walls and bottom. Easy access and cleaning box-shaped net filter. 2 years warranty.

| PRODUCT                    | CODE       | WEIGHT(KG) | PRICE      |
|----------------------------|------------|------------|------------|
| E10 AUTOMATIC POOL CLEANER | DST 091202 | 10KG       | 999,00 EUR |

## DOLPHIN "S100" AUTOMATIC POOL CLEANERS:



- Self-powered, 12 m cable for pools up to 8 m. The cleaning period is 1,5 hours. Self-programmed for optimal pool cleaning. Prevents algae and bacteria from forming by brushing the entire pool surface with the double brushing system that moves twice as fast as the robot. Cleans the pool floor, walls and waterline. It operates in standard cleaning mode via the new generation energy-saving power unit. Complete with mesh filter for collecting coarse dirt and cartridge filter for finer cleaning. Due to this, filter clogging takes much longer than other robots models. 2 years warranty.

| PRODUCT                        | CODE       | WEIGHT(KG) | PRICE        |
|--------------------------------|------------|------------|--------------|
| "S100" AUTOMATIC POOL CLEANERS | DST 091208 | 11KG       | 1.138,00 EUR |

## "S200" AUTOMATIC POOL CLEANERS



- Designed for residential pools up to 12 m. 24 V motor unit and 18 m cable. Cleaning cycle time 2 hours. Automatic program for optimal pool cleaning. Cleans the pool surface, walls and waterline. During climbing on the walls, it increases the vacuum according to the slipperiness, prevents to slip down. With patented POWERSTREAM technology, it has the most effective movement and manouvering features. Active brush which moves twice times faster than robot, removes the algea and bacteria on the walls and bottom. It works with standard cleaning mode with new generation energy saving power unit. Complete with 2 layer filtering system, cartridge filter and net filter for coarse dust. The cartridge filter remains clean much longer due to the 2 layer system. 3 years warranty

| PRODUCT                        | CODE       | WEIGHT(KG) | PRICE        |
|--------------------------------|------------|------------|--------------|
| "S200" AUTOMATIC POOL CLEANERS | DST 091203 | 12KG       | 1.311,00 EUR |

## "S300" AUTOMATIC POOL CLEANERS



- Self-powered, 18 m cable for pools up to 12 m. The cleaning period is 1 and 2 hours. Self-programmed for optimal pool cleaning. Patented POWER STREAM technology has more effective movement maneuvering and cleaning ability of the pool floor, wall and waterline. Prevents algae and bacteria from forming by brushing the entire pool surface with the double brushing system that moves twice as fast as the robot. Cleans the pool floor, walls and waterline. It operates in standard cleaning mode via the new generation energy-saving power unit. Thanks to its new layered filter, it separates the dirt by dimension and traps small and large-sized dirt separately. In this way, filter clogging takes much longer than other robots models. Complete with Caddy. 3 years warranty.

| PRODUCT                        | CODE       | WEIGHT(KG) | PRICE        |
|--------------------------------|------------|------------|--------------|
| "S300" AUTOMATIC POOL CLEANERS | DST 091209 | 19KG       | 1.493,00 EUR |

## “Standart” Automatic Pool Cleaners

- Designed for residential pools up to 12 m. 24 V motor unit and 18 m cable. Cleaning cycle time can be adjustable 1, 1.5, 2 or 2.5 hours. Automatic program for optimal pool cleaning. Cleans the pool surface, walls and waterline. During climbing on the walls, it increases the vacuum according to the slipperiness and prevents to slip down. With patented POWERSTREAM technology, it has the most effective movement and manouvering features. Active brush which moves twice times faster than robot, removes the algea and bacteria on the walls and bottom. It has different cleaning modes; fast, standard, ultra-clean, floor only and waterline

### "S300I" AUTOMATIC POOL CLEANERS



- Weekly timer and delayed start can be adjusted. it seperates the debris according to their sizes inside the 2 layer filtering system; net filter for coarse, cartridge filter for finer debris. It can be remote controlled with “MyDolphin” application via smartphones. Complete with caddy. 3 years warranty.

| PRODUCT                         | CODE       | WEIGHT(KG) | PRICE        |
|---------------------------------|------------|------------|--------------|
| "S300I" AUTOMATIC POOL CLEANERS | DST 091204 | 19KG       | 1.626,00 EUR |

## “M Series” Automatic Pool Cleaners

### DOLPHIN “M200” AUTOMATIC POOL CLEANERS



- Self-powered, 70-micron filter, 18 m cable, 24 V motor, 16 m3/h flow rate. Designed for home pools up to 10 m. The cleaning period is 3 hours. Self-programmed for optimal pool cleaning. Cleans the pool floor and the difficult to reach corners where the floor meets the pool wall. Patented Tangle Free Cable swivel system to avoid cable damage due to bending. Complete with caddy. 2 years warranty. NOTE: WALL CLIMBING IS NOT SUPPORTED BY THE M200. IF WALL CLEANING IS IMPORTANT, THE LOWEST MODEL THAT SHOULD BE SELECTED IS S200.

| PRODUCT                        | CODE       | WEIGHT(KG) | PRICE        |
|--------------------------------|------------|------------|--------------|
| "M200" AUTOMATIC POOL CLEANERS | DST 091171 | 16KG       | 1.095,00 EUR |

### DOLPHIN “M400” AUTOMATIC POOL CLEANERS



Kendinden motorlu, düşük mikronlu kartuş ya da ağ filtrelili, 18 m kablolu, 24 V motorlu, 16 m3/h debili. 10 - 12 m boy arası ev havuzları için tasarlanmıştır. Temizlik periyodu 2.5 saattir. Optimal havuz temizliği için kendinden programlıdır. Mikroprosesör kontrollüdür. Havuz duvarlarına su hattına kadar tırmanır. Patentli Fırdöndü sistemi ile kablo kıvrılmasına bağlı hasarı engeller. Trafo üzerinden ‘Günde bir, iki günde bir ve üç günde bir’ seçenekleriyle haftalık programlama imkanı sunulmuştur. MyDolphin Plus akıllı telefon uygulaması ile internet üzerinden elle kullanım ve haftalık programlama imkanı sunar. Filtrelere üstten kolay ulaşım imkanı. Daha üstün temizlik için süngerlerden 2 kat hızlı dönen aktif fırça. Kullanıcı tarafından kolaylıkla değiştirilebilir paletler. “ÇİFT HAREKET AKSI VE CAYROSKOP TEKNOLOJİSİ İLE ÇOK DAHA ETKİN HAVUZ TARAMA”. ARABASI İLE KOMPLE. 3 yıl garantilidir.

| PRODUCT                        | CODE       | WEIGHT(KG) | PRICE        |
|--------------------------------|------------|------------|--------------|
| "M400" AUTOMATIC POOL CLEANERS | DST 091181 | 24KG       | 1.665,00 EUR |

## “M Series” Automatic Pool Cleaners

New generation user-friendly with remote control power unit for setup and programming. Self-powered. Interchangeable low micron filter or mesh filter to remove both rough and fine dirt. 18 m cable, 24 V motor, 16 m<sup>3</sup>/h flow rate. Designed for home pools between 12-15 m in length. The cleaning period can be set as 2, 3, 4 hours. Self-programmed for optimal pool cleaning. Microprocessor controlled.

### DOLPHIN “M500” AUTOMATIC POOL CLEANERS



Climbs up to the pool walls to the waterline. With the patented Tangle Free Cable Swivel System, to prevent cable damage due bending. A wide range of options for cleaning programs and parameters can be set with the new generation remote control and ‘My Dolphin’ application which can be installed on smartphones e.g. Cycle time, Climbing frequency, Standard or Ultra cleaning. When the filter is clogged, it gives a cleaning signal on the power unit. Easy access to the filters from the top. Using the WiFi My Dolphin Plus application, users can intervene at anytime, from anywhere; e.g. cleaning modes, delayed time, and weekly timer settings can be made. Filter panels are easily changed by the user. “HIGHLY ACCURATE POOL SCANNING WITH GYROSCOPE TECHNOLOGY”. Complete with caddy. 3 year warranty.

| PRODUCT                        | CODE       | WEIGHT(KG) | PRICE         |
|--------------------------------|------------|------------|---------------|
| "M500" AUTOMATIC POOL CLEANERS | DST 091182 | 24KG       | 2..137,00 EUR |

Self-powered. 18 m cable, designed for pools up to 15 m. Cleaning cycle can be programmed as 1.5, 2, 2.5 hours for optimal cleaning. With its patented DUAL DRIVE POWERSTREAM technology, it offers more effective movement, maneuvering and cleaning ability to the pool floor, wall and waterline.

### DOLPHIN “M600” AUTOMATIC POOL CLEANERS



Prevents algae and bacteria from forming by brushing the entire pool surface with the double speed brushing system that moves two times faster than the robot. It is available with fast, standard, ultra-clean cleaning options. Thanks to its new layered filter, it separates the dirt particles by dimension and traps small and large-sized dirt separately. Thus, filter clogging takes longer than other models. It can be remotely controlled with the My Dolphin Plus application, which can be installed on smartphones, and allows the user to intervene on the internet anytime and anywhere; adjusting cleaning modes, delayed time settings and weekly timer settings etc. Complete with caddy. 3 year warranty.

| PRODUCT                        | CODE       | WEIGHT(KG) | PRICE        |
|--------------------------------|------------|------------|--------------|
| "M600" AUTOMATIC POOL CLEANERS | DST 091183 | 24KG       | 2.372,00 EUR |

## Automatic Pool Cleaners for Special Pools

### DOLPHIN “BIO-S” AUTOMATIC POOL/POND CLEANERS



Designed especially for 15 m Ecologic/ Natural Swimming Pools and Ponds. 18 m cable, patented swivel technology avoids the harm caused by cable bend. Cleaning cycle time can be selected 2, 3 or 4 hours. Next to 70 micron cartridge filter, there is an additional vacuum line that can connect to filtration system for the accumulation of the extra rough dirt. Thus, while rough dirt such as leaves and mud are kept in a central filter, small size dirt kept in cartridge filter. GEMAS Portable Vacuum Cleaners (see. Pg 211) can provide an effective and automatic cleaning in a pool that has no vacuum line. For better cleaning, standard extra 3rd brush. It's complete with user-friendly remote control and power unit. Complete with caddy. 2 year warranty

| PRODUCT                         | CODE       | WEIGHT(KG) | PRICE        |
|---------------------------------|------------|------------|--------------|
| "BIO-S" AUTOMATIC POOL CLEANERS | DST 091211 | 24KG       | 3.900,00 EUR |

# Automatic Pool Cleaners for Commercial Pools

## DOLPHIN "2 X 2 PRO GYRO" AUTOMATIC POOL CLEANER:



New generation user friendly remote control and power supply. Two 50 micron self filters either disposable or permanent, 40 m cable, 24 V motor unit, 32 m3/h flow rate. Designed for commercial pools up to 60 m. Cleaning cycle time can be selected as 4, 6 or 8 hours. Gyroscope navigation provides precise pool scanning. Different cleaning modes and parameters can be selected for optimal pool cleaning; cycle time, pool length, climbing frequency, regular or ultra cleaning, water line definition. Climbs the pool walls and water lines. Warning signal when filter is blocked. Complete with caddy and remote control. 2 year warranty.

| PRODUCT                               | CODE       | WEIGHT(KG) | PRICE        |
|---------------------------------------|------------|------------|--------------|
| "2X2 PRO GYRO" AUTOMATIC POOL CLEANER | DST 091151 | 44KG       | 7.682,00 EUR |

## DOLPHIN "WAVE 30" AUTOMATIC POOL CLEANER:



Effective pool scanning with double motion axle. 70 micron "permanent" or "disposable" type filters. 18 m cable. 16 m3/h flow rate, 24 V motor. Design for pools up to 15 m. Patented swivel system avoids the harm caused by cable bend. Cleaning cycle time is 3 hours. Climbing frequency is 8 minutes. Complete with Caddy. 3 year warranty

| PRODUCT                          | CODE       | WEIGHT(KG) | PRICE        |
|----------------------------------|------------|------------|--------------|
| "WAVE 30" AUTOMATIC POOL CLEANER | DST 091201 | 44         | 2.456,00 EUR |

## DOLPHIN "C4" AUTOMATIC POOL CLEANER:



New generation user-friendly remote control power unit. Designed for pools up to 20 m. Self-powered, low micron cartridge or mesh filter, 24 m cable, 24 V motor, 17 m3/h flow rate. The cleaning period can be set as 1.5, 2.5, 3.5 hours. Non-deflection pool scanning powered by gyroscope technology. Self-programmed and microprocessor-controlled for optimal pool cleaning. Climbs up the pool wall. It signals when its filter is clogged. Easy access to the filters from the top. Complete with caddy. 2 year warranty.

| PRODUCT                     | CODE       | WEIGHT(KG) | PRICE        |
|-----------------------------|------------|------------|--------------|
| "C4" AUTOMATIC POOL CLEANER | DST 091172 | 24KG       | 2.875,00 EUR |

## DOLPHIN "WAVE 50" AUTOMATIC POOL CLEANER:



Effective pool scanning in 4 hours, with the double motion axle. 70 micron "permanent" or "disposable" type filters. 24 m cable. 16 m3/h flow rate, 24 V motor. Design for pools up to 20 m. Patented swivel system avoids the harm caused by cable bend. Cleaning cycle time is 3 hours. Climbing frequency is 8 minutes. Complete with Caddy. 3 year warranty.

| PRODUCT                         | CODE       | WEIGHT(KG) | PRICE        |
|---------------------------------|------------|------------|--------------|
| "WAVE50" AUTOMATIC POOL CLEANER | DST 091122 | 23KG       | 2.788,00 EUR |

# Automatic Pool Cleaners for Commercial Pools

## DOLPHIN "WAVE 100" AUTOMATIC POOL CLEANER:



New generation user-friendly remote control and power unit. Effective pool scanning in 4 hours, with the double motion axle. 70 micron "permanent" or "disposable" type filters. 24 m cable. 16 m<sup>3</sup>/h flow rate, 24 V motor. Design for pools up to 25 m. Patented swivel system avoids the harm caused by cable bend. Cleaning cycle time is 3 hours. Climbing frequency is 8 minutes. Complete with Caddy. 3 year warranty

| PRODUCT                          | CODE       | WEIGHT(KG) | PRICE        |
|----------------------------------|------------|------------|--------------|
| "WAVE100" AUTOMATIC POOL CLEANER | DST 091142 | 25KG       | 3.963,00 EUR |

## DOLPHIN "WAVE 200" AUTOMATIC POOL CLEANER:



It provides professional cleaning for pools up to 40 m. It separates the dust inside the water to 3 different sizes and increases filtration area by cycling the water. All filter layers can be separated and used individually. With the help of Man-Machine Interface (MMI), specifications of the pool can be installed and max performance is obtained. With the navigation system, the robot has the most accurate navigating capabilities. Active brushes, prevents the algae and bacteria growth. 40 m<sup>3</sup>/h flow rate. Geometric design of monoblock brushes, pushes the dirt directly to vacuum holes. The specifications of MMI, navigation system and 4 of different pool memory are identical with Wave 300XL. Complete with Caddy. 2 year warranty.

| PRODUCT                          | CODE       | WEIGHT(KG) | PRICE         |
|----------------------------------|------------|------------|---------------|
| "WAVE200" AUTOMATIC POOL CLEANER | DST 091207 | 91KG       | 10.187,00 EUR |

## DOLPHIN "WAVE 300 XL" AUTOMATIC POOL CLEANER:



50 micron three different types of filters; standard, coarse and disposable. Complete with caddy, user friendly interactive control panel, and remote control. Designed for commercial pools up to 60 m. scanning guarantee for 100% of the pool with the navigation technology that is used for the first time in automatic pool cleaners. Can memorize four different pools. Complete with Caddy. 2 year warranty.

| PRODUCT                             | CODE       | WEIGHT(KG) | PRICE         |
|-------------------------------------|------------|------------|---------------|
| "WAVE 300XL" AUTOMATIC POOL CLEANER | DST 091161 | 101KG      | 14.599,00 EUR |

# POOL CLEANING EQUIPMENT

## ALUMINUM FLAT CLEANER (CLIP - TYPE)

| IMAGE | CODE    | TYPE OF MATERIAL          | PRICE     |
|-------|---------|---------------------------|-----------|
|       | DSTSP01 | 1 1/2" Flat Modal Cleaner | 42,00 EUR |
|       | DSTSP02 | 2" Flat Modal Cleaner     | 48,00 EUR |

## ALUMINUM FLAT CLEANER (BOLTED TYPE)

| IMAGE | CODE       | TYPE OF MATERIAL          | PRICE     |
|-------|------------|---------------------------|-----------|
|       | DSTSP01 -C | 1 1/2" Flat Modal Cleaner | 42,00 EUR |
|       | DSTSP02 -C | 2" Flat Modal Cleaner     | 48,00 EUR |

## ALUMINUM TELESCOPIC HANDLE

| IMAGE | CODE    | TYPE OF MATERIAL      | PRICE     |
|-------|---------|-----------------------|-----------|
|       | DSTTS01 | 2X2 Telescopic Handle | 30,00 EUR |
|       | DSTTS02 | 2X3 Telescopic Handle | 35,00 EUR |
|       | DSTTS03 | 2X4 Telescopic Handle | 50,00 EUR |
|       | DSTTS04 | 3X3 Telescopic Handle | 55,00 EUR |

## VACUUM HOSE



| IMAGE | CODE     | TYPE OF MATERIAL     | PRICE    |
|-------|----------|----------------------|----------|
|       | DSTEVA01 | 1 1/2" Vakum Hortumu | 5,00 EUR |
|       | DSTEVA02 | 2" Vakum Hortumu     | 7,00 EUR |

## HOSE ADAPTERS

| IMAGE | CODE    | TYPE OF MATERIAL           | PRICE    |
|-------|---------|----------------------------|----------|
|       | DSTHU01 | 1 1/2" Hose Adapter        | 5,00 EUR |
|       | DSTHU02 | 2" Hose Adapter            | 7,00 EUR |
|       | DSTLB01 | ABS - 1 1/2" Hose Nozzle   | 7,00 EUR |
|       | DSTLB02 | ABS 1 1/2" - 2"Hose Nozzle | 7,00 EUR |



# POOL CLEANING EQUIPMENT

| DST BRUSHES   |       |                        |         |            |        |           |
|---|-------|------------------------|---------|------------|--------|-----------|
| IMAGE   | CODE  | TYPE OF MATERIAL       | PACKAGE | WEIGHT(KG) | VOLUME | PRICE     |
|  | DSTF1 | Short Type Brush       | 24      | 4,8        | 0,028  | 10,00 EUR |
|  | DSTF2 | Curved Long Type Brush | 24      | 6,6        | 0,049  | 12,00 EUR |
|  | DSTF9 | Corner Brush           | 24      | 3          | 0,033  | 10,00 EUR |

| DST DEEP TYPE LEAF SCOOP   |       |                  |         |            |        |           |
|--|-------|------------------|---------|------------|--------|-----------|
| IMAGE  | CODE  | TYPE OF MATERIAL | PACKAGE | WEIGHT(KG) | VOLUME | PRICE     |
|  | DSTF1 | Lux Leaf Scoop   | 12      | 6          | 0,083  | 15,00 EUR |

| DST THERMOMETERS  |         |                                     |         |           |
|---|---------|-------------------------------------|---------|-----------|
| IMAGE   | CODE    | TYPE OF MATERIAL                    | PACKAGE | PRICE     |
|  | DSTTM01 | Economic Floating Type Thermometers | 1       | 5,00 EUR  |
|   | DSTTM02 | Economic Thermometers               | 1       | 20,00 EUR |
|   | DSTTM03 | Floating Type Thermometers          | 1       | 20,00 EUR |

## DST Test Kits

DST Test kits are used to analyze the chlorine and PH values of the pools. There are two types of test kits, liquid and tablet.

| DST TEST KITS  |         |                  |            |           |
|--|---------|------------------|------------|-----------|
| IMAGE  | CODE    | TYPE OF MATERIAL | BOX/PIECES | PRICE     |
|  | DSTTK01 | TABLET           | 1          | 15,00 EUR |
|  | DSTTK01 | LIQUID           | 1          | 12,00 EUR |



# POOL CHEMICALS

# POOL CHEMICALS

| AQUA LIFE POOL CHEMICALS |  |                        |
|--------------------------|--|------------------------|
| IMAGE                    | TYPE OF MATERIAL                               | WEIGHT (KG)            |
|                          | GRANULE CHLOR 56 (56 LIKE CHLORINE STABILIZER) | 50                     |
|                          | GRANULE CHLOR 56 (56 LIKE CHLORINE STABILIZER) | 25                     |
|                          | GRANULE CHLOR 56 (56 LIKE CHLORINE STABILIZER) | 50<br>(PLASTIC BARREL) |
|                          | GRANULE CHLOR 90 (90 LIKE CHLORINE STABILIZER) | 50                     |
|                          | GRANULE CHLOR 90 (90 LIKE CHLORINE STABILIZER) | 25                     |
|                          | GRANULE CHLOR 90 (90 LIKE CHLORINE STABILIZER) | 50<br>(PLASTIC BARREL) |
|                          | CHLOR TAB TABLET CHLORINE (WITH STABILIZER)    | 50                     |
|                          | CHLOR TAB TABLET CHLORINE (WITH STABILIZER)    | 25                     |
|                          | MINUS (DUST PH REDUCER)                        | 25                     |
|                          | MINUS (DUST PH REDUCER)                        | 25<br>(BAG)            |
|                          | ALGAECIDE                                      | 20                     |
|                          | FLOCK (LIQUID EXTRACTOR)                       | 20                     |
|                          | CLEANSE  | 20                     |

| AUXILIARY POOL CHEMICALS |   |             |
|--------------------------|---|-------------|
| IMAGE                    | TYPE OF MATERIAL                                    | WEIGHT (KG) |
|                          | MULTI TABLET CHLORINE (3 EFFECTIVE TABLET CHLORINE) | 50          |
|                          | 70% CALCIUM HYPOCHLORIDE (WITHOUT STABILIZER)       | 40          |
|                          | ACID - (POWDER) (FILTER CLEANER)                    | 25          |
|                          | PH + PLUS (PH BOOSTER)                              | 25          |
|                          | HYDRO- (SURFACE CLEANER)                            | 20          |

PLEASE ASK PRICE FOR POOL CHEMICALS



POOL  
LADDERS

# DST POOL LADDERS

DST Pool Ladders are manufactured three types as Standard, Muro and Mixto with 2,3,4, and 5-step options, which are obtained by using stainless steel.(316 and 304).

## STANDARD LADDERS

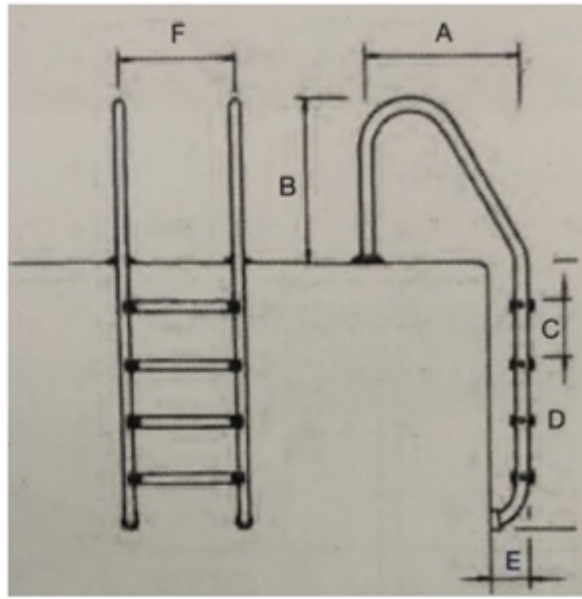

| CODE (AISI 304) | Step | A(mm) | B(mm) | C(mm) | D(mm) | E(mm) | F(mm) | PRICE      |
|-----------------|------|-------|-------|-------|-------|-------|-------|------------|
| DST MRD01       | 2    | 650   | 620   | 250   | 710   | 180   | 500   | 170,00 EUR |
| DST MRD02       | 3    | 650   | 620   | 250   | 960   | 180   | 500   | 180,00 EUR |
| DST MRD03       | 4    | 650   | 620   | 250   | 1210  | 180   | 500   | 190,00 EUR |
| DST MRD04       | 5    | 650   | 620   | 250   | 1460  | 180   | 500   | 215,00 EUR |
| CODE (AISI 316) | Step | A(mm) | B(mm) | C(mm) | D(mm) | E(mm) | F(mm) | PRICE      |
| DST MRD013      | 2    | 650   | 620   | 250   | 710   | 180   | 500   | 260,00 EUR |
| DST MRD014      | 3    | 650   | 620   | 250   | 960   | 180   | 500   | 290,00 EUR |
| DST MRD015      | 4    | 650   | 620   | 250   | 1210  | 180   | 500   | 320,00 EUR |
| DST MRD016      | 5    | 650   | 620   | 250   | 1460  | 180   | 500   | 350,00 EUR |

# DST POOL LADDERS

## "MURO" LADDERS

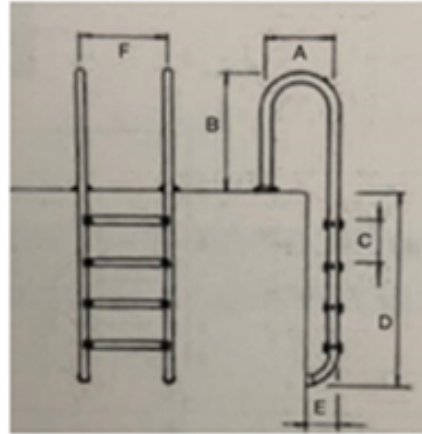

| CODE (AISI 304) | Step | A(mm) | B(mm) | C(mm) | D(mm) | E(mm) | F(mm) | PRICE      |
|-----------------|------|-------|-------|-------|-------|-------|-------|------------|
| DST MRD05       | 2    | 350   | 620   | 250   | 710   | 180   | 500   | 170,00 EUR |
| DST MRD06       | 3    | 350   | 620   | 250   | 960   | 180   | 500   | 180,00 EUR |
| DST MRD07       | 4    | 350   | 620   | 250   | 1210  | 180   | 500   | 190,00 EUR |
| DST MRD08       | 5    | 350   | 620   | 250   | 1460  | 180   | 500   | 215,00 EUR |
| CODE (AISI 316) | Step | A(mm) | B(mm) | C(mm) | D(mm) | E(mm) | F(mm) | PRICE      |
| DST MRD017      | 2    | 350   | 620   | 250   | 710   | 180   | 500   | 260,00 EUR |
| DST MRD018      | 3    | 350   | 620   | 250   | 960   | 180   | 500   | 290,00 EUR |
| DST MRD019      | 4    | 350   | 620   | 250   | 1210  | 180   | 500   | 320,00 EUR |
| DST MRD020      | 5    | 350   | 620   | 250   | 1460  | 180   | 500   | 350,00 EUR |

# DST POOL LADDERS

## "MIXTO" LADDERS

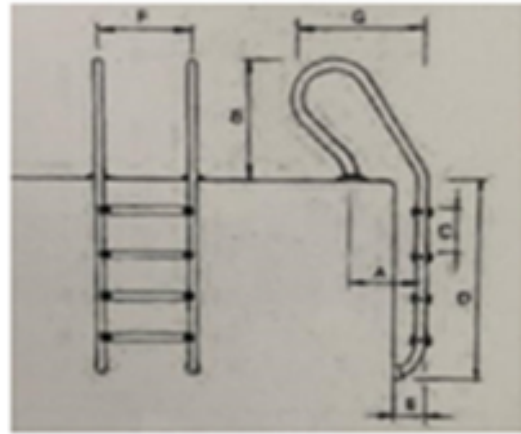

| CODE (AISI 316) | Step | A(mm) | B(mm) | C(mm) | D(mm) | E(mm) | F(mm) | G(mm) | PRICE      |
|-----------------|------|-------|-------|-------|-------|-------|-------|-------|------------|
| DST MRD09       | 2    | 350   | 620   | 250   | 710   | 180   | 500   | 520   | 170,00 EUR |
| DST MRD010      | 3    | 350   | 620   | 250   | 960   | 180   | 500   | 520   | 180,00 EUR |
| DST MRD011      | 4    | 350   | 620   | 250   | 1210  | 180   | 500   | 520   | 190,00 EUR |
| DST MRD12       | 5    | 350   | 620   | 250   | 1460  | 180   | 500   | 520   | 215,00 EUR |
| CODE (AISI 316) | Step | A(mm) | B(mm) | C(mm) | D(mm) | E(mm) | F(mm) | G(mm) | PRICE      |
| DST MRD017      | 2    | 350   | 620   | 250   | 710   | 180   | 500   | 520   | 260,00 EUR |
| DST MRD018      | 3    | 350   | 620   | 250   | 960   | 180   | 500   | 520   | 290,00 EUR |
| DST MRD019      | 4    | 350   | 620   | 250   | 1210  | 180   | 500   | 520   | 320,00 EUR |
| DST MRD020      | 5    | 350   | 620   | 250   | 1460  | 180   | 500   | 520   | 350,00 EUR |



# WATER CURTAINS







# DST WATER CURTAINS

DST WATER CURTAINS are manufactured from stainless steel(AISI 316) in different models and sizes.

| CURTAIN OF WATER LUX  |          |            |              |
|---|----------|------------|--------------|
| IMAGE   | CODE     | SIZE       | PRICE        |
|  | DSTDPE01 | 1000 X 400 | 1.408,00 EUR |
|   | DSTDPE02 | 1000 X 500 | 1.525,00 EUR |
|   | DSTDPE03 | 1000 X 600 | 1.643,00 EUR |

| CURTAIN OF WATER COBRA  |          |           |              |
|---|----------|-----------|--------------|
| IMAGE   | CODE     | SIZE      | PRICE        |
|  | DSTDPE04 | 350 X 350 | 800,00 EUR   |
|   | DSTDPE05 | 800 X 600 | 1.130,00 EUR |
|   | DSTDPE06 | 900 X 600 | 1.400,00 EUR |

| CURTAIN OF WATER SWAN   |          |            |            |
|---|----------|------------|------------|
| IMAGE   | CODE     | SIZE       | PRICE      |
|  | DSTDPE07 | 1000 X 400 | 850,00 EUR |
|   | DSTDPE08 | 1000 X 600 | 970,00 EUR |

| CURTAIN OF WATER STANDART   |          |            |              |
|---|----------|------------|--------------|
| IMAGE   | CODE     | SIZE       | PRICE        |
|  | DSTDPE09 | 1000 X 400 | 850,00 EUR   |
|   | DSTDPE10 | 1000 X 500 | 1.260,00 EUR |
|   | DSTDPE11 | 1000 X 600 | 1.400,00 EUR |

| WALL TYPE CURTAIN OF WATER  |          |           |            |
|---|----------|-----------|------------|
| IMAGE   | CODE     | SIZE      | PRICE      |
|  | DSTDPE12 | 137 X 300 | 485,00 EUR |
|   | DSTDPE13 | 137 X 500 | 610,00 EUR |

| INTRA - WALL WATER CURTAIN  |          |          |            |
|---|----------|----------|------------|
| IMAGE   | CODE     | SIZE     | PRICE      |
|  | DSTDPE14 | 65 X 500 | 730,00 EUR |

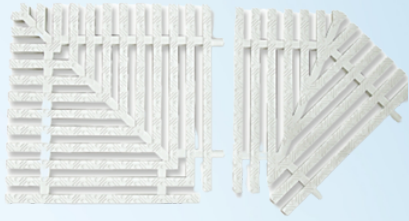



CORNER  
PIECES  
&  
GRATINGS





# DST GRATING & CORNER PIECES

DST corner pieces, single and double spine gratings are manufactured in sizes of 15,20,25 and 30 meters, in standard and many different models, which are obtained by using by high quality raw materials.

| SINGLE SPINE GRATING  |           |      |           |
|---|-----------|------|-----------|
| IMAGE   | CODE      | SIZE | PRICE     |
|  | DSTIZG001 | 15cm | 7,00 EUR  |
|   | DSTIZG002 | 20cm | 8,00 EUR  |
|   | DSTIZG003 | 25cm | 10,00 EUR |
|   | DSTIZG007 | 30cm | 17,00 EUR |

| DOUBLE SPINE GRATING   |           |      |           |
|--|-----------|------|-----------|
| IMAGE  | CODE      | SIZE | PRICE     |
|  | DSTIZG004 | 20cm | 8,00 EUR  |
|  | DSTIZG005 | 25cm | 10,00 EUR |
|  | DSTIZG006 | 30cm | 17,00 EUR |

| 45° CORNER PIECE  |         |      |           |
|---|---------|------|-----------|
| IMAGE   | CODE    | SIZE | PRICE     |
|  | DSTKP01 | 15cm | 7,00 EUR  |
|   | DSTKP02 | 20cm | 8,00 EUR  |
|   | DSTKP03 | 25cm | 10,00 EUR |
|   | DSTKP04 | 30cm | 20,00 EUR |

| 90° CORNER PIECE  |         |      |           |
|---|---------|------|-----------|
| IMAGE   | CODE    | SIZE | PRICE     |
|  | DSTKP05 | 15cm | 7,00 EUR  |
|   | DSTKP06 | 20cm | 8,00 EUR  |
|   | DSTKP07 | 25cm | 10,00 EUR |
|   | DSTKP08 | 30cm | 20,00 EUR |



# NOZZLES

# DST POOL NOZZLES



| BASE NOZZLE (FLOW ADJUSTABLE)   |          |      |          |
|---|----------|------|----------|
| IMAGE   | CODE     | SIZE | PRICE    |
|  | DSTYBN01 | D-63 | 3,00 EUR |
|   | DSTYBN02 | D-50 | 3,00 EUR |

| SIDE NOZZLE (WALL)   |          |      |          |
|--|----------|------|----------|
| IMAGE  | CODE     | SIZE | PRICE    |
|  | DSTTBN01 | D-63 | 3,00 EUR |
|  | DSTTBN02 | D-50 | 3,00 EUR |

| VACUUM NOZZLE   |         |      |          |
|---|---------|------|----------|
| IMAGE   | CODE    | SIZE | PRICE    |
|  | DSTVN01 | D-63 | 3,00 EUR |
|   | DSTVN02 | D-50 | 4,00 EUR |

| MAIN DRAIN  |           |              |           |
|---|-----------|--------------|-----------|
| IMAGE   | CODE      | SIZE         | PRICE     |
|  | DSTKDI 01 | 200 X 200 cm | 12,00 EUR |
|   | DSTKDI 02 | 250 X 250 cm | 15,00 EUR |
|   | DSTKDI 03 | 410 X 410 cm | 75,00 EUR |



# POOL LIGHTS



## DST POOL LIGHTS

The frame is made of white ABS plastic, without chassis. Complete with polycarbonate lamp body with LED in various numbers and powers, epoxy PCB and 2.5 m long, 2 x 1.5 cable embedded in special transparent resin.



### DST POOL LIGHTS

| IMAGE  | CODE        | TYPE OF MATERIAL                 | WEIGHT (KG) | VOLUME(M2) | PRICE     |
|--|-------------|----------------------------------|-------------|------------|-----------|
|  | DSTECOL01   | 72 LED White - 23 W              | 0,835       | 0,005      | 32,00 EUR |
|  | DSTECOL02   | 72 LED Day Light - 23 W          | 0,835       | 0,005      | 32,00 EUR |
|  | DSTECOL03   | 72 LED Turquoise - 20 W          | 0,835       | 0,005      | 32,00 EUR |
|  | DSTECOL04   | 72 LED Blue- 20 W                | 0,835       | 0,005      | 32,00 EUR |
|  | DSTECOL05   | 72 LED Red - 20 W                | 0,835       | 0,005      | 32,00 EUR |
|  | DSTECOL06   | 72 LED Green - 20 W              | 0,835       | 0,005      | 32,00 EUR |
|  | DSTECORGB01 | 72 LED RGB-SELF-INTEGRATED 20W   | 0,835       | 0,005      | 57,00 EUR |
|  | DSTECORGB02 | 72 LED RGB-CENTER INTEGRATED 20W | 0,835       | 0,005      | 44,00 EUR |
|  | DSTKVN01    | BEYAZ ABS STANDARD LAMP BASE     | -           | -          | 15,00 EUR |

## NOZBART®

### POOL LIGHTS

#### ALTIN ORAN SMD LED POOL LAMP

| IMAGE  | CODE (ABS)    | Color    | Led  | Lumen   | Volt       | Watt      | PRICE     |
|--|---------------|----------|------|---------|------------|-----------|-----------|
|  | ALOR-101      | Beyaz    | 120  | 3600    | AC/DC 12 V | 32 W      | 59,00 EUR |
|  | ALOR-102      | Günişığı | 120  | 3600    | AC/DC 12 V | 32 W      | 59,00 EUR |
|  | ALOR-103      | Mavi     | 120  | 2400    | AC/DC 12 V | 32 W      | 59,00 EUR |
|  | ALOR-104      | RGB      | 96   | 3200    | DC 12 V    | 30 W      | 72,00 EUR |
|  | CODE (CHROME) | Color    | Led  | Lumen   | Volt       | Watt      | PRICE     |
|  | ALOR-101K     | Beyaz    | 120  | 3600    | AC/DC 12 V | 32 W      | 68,80 EUR |
|  | ALOR-102K     | Günişığı | 120  | 3600    | AC/DC 12 V | 32 W      | 68,80 EUR |
|  | ALOR-103K     | Mavi     | 120  | 2400    | AC/DC 12 V | 32 W      | 68,80 EUR |
| ALOR-104K  | RGB           | 96       | 3200 | DC 12 V | 30 W       | 81,80 EUR |           |

#### ALTIN ORAN LINER KIT

| CODE     | PRICE     |
|----------|-----------|
| ALOR-K01 | 27,30 EUR |

#### ALTIN ORAN PANEL POLYESTER KIT

| CODE     | PRICE     |
|----------|-----------|
| ALOR-K02 | 28,30 EUR |

### İŞİL SERIES SMD LED POOL LAMP

| IMAGE | CODE (ABS)    | Color     | Led | Lumen | Volt       | Watt | PRICE     |
|-------|---------------|-----------|-----|-------|------------|------|-----------|
|       | NIA-101       | White     | 120 | 3600  | AC/DC 12 V | 32 W | 59,00 EUR |
|       | NIA-102       | Day Light | 120 | 3600  | AC/DC 12 V | 32 W | 59,00 EUR |
|       | NIA-103       | Blue      | 120 | 2400  | AC/DC 12 V | 32 W | 59,00 EUR |
|       | NIA-104       | RGB       | 96  | 3200  | DC 12 V    | 30 W | 72,00 EUR |
|       | CODE (CHROME) | Color     | Led | Lumen | Volt       | Watt | PRICE     |
|       | NIA-101K      | White     | 120 | 3600  | AC/DC 12 V | 32 W | 68,80 EUR |
|       | NIA-102K      | Day Light | 120 | 3600  | AC/DC 12 V | 32 W | 68,80 EUR |
|       | NIA-103K      | Blue      | 120 | 2400  | AC/DC 12 V | 32 W | 68,80 EUR |
|       | NIA-104K      | RGB       | 96  | 3200  | DC 12 V    | 30 W | 81,80 EUR |

### İŞİL SERIES LED LINER KIT

| CODE    | PRICE     |
|---------|-----------|
| NIA-K01 | 27,30 EUR |

### İŞİL SERIES LED / POLYESTER KIT

| CODE    | PRICE     |
|---------|-----------|
| NIA-K02 | 28,30 EUR |

### İŞİL SERIES SMD LED PAR56 COMPATIBLE LIGHT BULB

| IMAGE | CODE    | Color     | Led | Lumen | Volt       | Watt | PRICE     |
|-------|---------|-----------|-----|-------|------------|------|-----------|
|       | NIA-201 | White     | 120 | 3600  | AC/DC 12 V | 32 W | 58,50 EUR |
|       | NIA-202 | Day Light | 120 | 3600  | AC/DC 12 V | 32 W | 58,50 EUR |
|       | NIA-203 | Blue      | 120 | 2400  | AC/DC 12 V | 32 W | 58,50 EUR |
|       | NIA-204 | RGB       | 96  | 3200  | DC 12 V    | 30 W | 71,50 EUR |

### İŞİL SERIES SMD LED PAR56 CASED POOL LAMP

| IMAGE | CODE (ABS)    | Color     | Led | Lumen | Volt       | Watt | Kelvin                                 | PRICE      |
|-------|---------------|-----------|-----|-------|------------|------|--|------------|
|       | NIA-301       | White     | 120 | 3600  | AC/DC 12 V | 32 W | 6500 K                                 | 92,30 EUR  |
|       | NIA-302       | Day Light | 120 | 3600  | AC/DC 12 V | 32 W | 3000 K                                 | 92,30 EUR  |
|       | NIA-303       | Blue      | 120 | 2400  | AC/DC 12 V | 32 W | 450 - 460nm                            | 92,30 EUR  |
|       | NIA-304       | RGB       | 96  | 3200  | DC 12 V    | 30 W | R(620-630nm) G(520-530nm) B(460-475nm) | 105,30 EUR |
|       | CODE (CHROME) | Color     | Led | Lumen | Volt       | Watt | Kelvin                                 | PRICE      |
|       | NIA-301K      | White     | 120 | 3600  | AC/DC 12 V | 32 W | 6500 K                                 | 102,10 EUR |
|       | NIA-302K      | Day Light | 120 | 3600  | AC/DC 12 V | 32 W | 3000 K                                 | 102,10 EUR |
|       | NIA-303K      | Blue      | 120 | 2400  | AC/DC 12 V | 32 W | 450-460nm                              | 102,10 EUR |
|       | NIA-304K      | RGB       | 96  | 3200  | DC 12 V    | 30 W | R(620-630nm) G(520-530nm) B(460-475nm) | 115,10 EUR |



| IŞIL SMD LED PAR56 CASED POOL LAMP |            |
|------------------------------------|------------|
| CODE LINER (ABS)                   | PRICE      |
| NIA-401                            | 115,20 EUR |
| NIA-402                            | 115,20 EUR |
| NIA-403                            | 115,20 EUR |
| NIA-404                            | 128,20 EUR |

| IŞIL SMD LED PAR56 CASED POOL LAMP |            |
|------------------------------------|------------|
| CODE LINER (CHROME)                | PRICE      |
| NIA-401K                           | 125,00 EUR |
| NIA-402K                           | 125,00 EUR |
| NIA-403K                           | 125,00 EUR |
| NIA-404K                           | 138,00 EUR |

| IŞIL SERIES SMD LED PAR56 POOL LAMP WITHOUT FRAME |            |           |       |         |            |            |           |
|---|------------|-----------|-------|---------|------------|------------|-----------|
| IMAGE   | CODE (ABS) | Color     | Led   | Lumen   | Volt       | Watt       | PRICE     |
|   |            | NIA-501   | White | 120     | 3600       | AC/DC 12 V | 32 W      |
| NIA-502   |            | Day Light | 120   | 3600    | AC/DC 12 V | 32 W       | 79,90 EUR |
| NIA-503   |            | Blue      | 120   | 2400    | AC/DC 12 V | 32 W       | 79,90 EUR |
| NIA-504   |            | RGB       | 96    | 3200    | DC 12 V    | 30 W       | 92,80 EUR |
| CODE (CHROME)                                     |            | Color     | Led   | Lumen   | Volt       | Watt       | PRICE     |
| NIA-501K  |            | White     | 120   | 3600    | AC/DC 12 V | 32 W       | 89,70 EUR |
| NIA-502K  |            | Day Light | 120   | 3600    | AC/DC 12 V | 32 W       | 89,70 EUR |
| NIA-503K  |            | Blue      | 120   | 2400    | AC/DC 12 V | 32 W       | 89,70 EUR |
| NIA-504K  | RGB        | 96        | 3200  | DC 12 V | 30 W       | 102,60 EUR |           |

| POWER LED COLORFUL ANIMATION BOX WITH REMOTE CONTROLLER |         |       |        |        |         |             |              |
|---|---------|-------|--------|--------|---------|-------------|--------------|
| IMAGE   | CODE    | POWER | ENTER  | EXIT   | SIZE    | LAMP PIECES | PRICE        |
|   | PAN-001 | 350 W | 220 AC | 12V DC | 30 X 40 | 10          | 496,00 EUR   |
|   | PAN-002 | 350 W | 220 AC | 12V DC | 30 X 40 | 20          | 778,00 EUR   |
|   | PAN-003 | 350 W | 220 AC | 12V DC | 50 X 70 | 30          | 1.066,00 EUR |
|   | PAN-004 | 350 W | 220 AC | 12V DC | 50 X 70 | 50          | 1.720,00 EUR |
|   | PAN-005 | 350 W | 220 AC | 12V DC | 50 X 70 | 90          | 2.995,00 EUR |



PVC

ADHESIVES

# DST FAST-1 PVC ADHESIVES

DST F-1 adhesives play a major role in the fast and accurate implementation of the mechanical assembly.

The system becomes operational 15-20 minutes after the adhesive is applied. T

here are brushes in our 1 kg packages and you can easily make your PVC assemblies.

The shelf life of our products is 2 years.



## DST FAST - 1 RIGID PVC - U ADHESIVE

| IMAGE | CODE    | TYPE OF MATERIAL | BOX / PIECES | PRICE     |
|-------|---------|------------------|--------------|-----------|
|       | DSTF101 | TRANSPARENT      | 1            | 16,00 EUR |
|       | DSTF102 | GREY             | 1            | 16,00 EUR |



@DSTPOOL

*follow us*

**WWW.DSTPOOL.COM**  
**SALES@DSTPOOL.COM**

*D.S.T*

